

Car Show™ 7.0

By **ROSEN**

OWNER'S MANUAL **All-In-One System**



- **Color 7.0" Wide-Screen LCD Monitor**
- **Integrated DVD/CD/MP3 Player**
- **Adjustable Screen Angle**
- **IR Transmitter For Wireless Headphones**
- **Wireless Remote Control**
- **Parental Controls**
- **NTSC/PAL**

Rosen Entertainment Systems

1120 California Avenue • Corona, California 92881 USA

PH: (951) 898-9808 • FAX: (951) 898-9897

EMAIL: info@rosenentertainment.com • WEB: www.rosenentertainment.com

COPYRIGHT ROSEN 06.05

CONTENTS

- Safety Information4**
- Disc Notes5**
- The Player6**
- Remote Control.....7**
 - Location and Function of Keys.....7
 - Preparing the Remote Control.....9
- Loading/Ejecting a Disc9**
 - Loading a Disc.....9
 - Ejecting a Disc.....9
- Operation.....10**
 - Basic Play10
 - Display Adjust Function.....11
 - On-Screen Display Function.....11
 - Multi-Subtitle Language Function12
 - MP3 Disc Play13
- Setup.....14**
 - Initial Setup.....14
 - General Setup.....14
 - Speaker Setup.....16
 - Audio Setup.....16
 - Preferences Setup.....17
 - Defaults Table.....19
- Installation20**
- Electrical Connection.....21**
- Replacing the Car Dome Lamp22**
- Trouble Shooting.....23**
- Specifications.....24**

NOTICES

Use the Proper Power Supply

This product is designed to operate with a 12 volt DC, negative ground battery system (the regular system in a North American car).

Protect the Disc Mechanism

Avoid inserting any foreign objects into the slot of this player. Failure to observe this may cause malfunction to the DVD mechanism in this unit.

Use Rosen Authorized Dealers

Do not attempt to disassemble or adjust this precision product. Please refer to www.rosenentertainment.com for a list of authorized dealers in your area for service assistance.

For Installation

The unit is designed for overhead installation.

About Registered Marks

This product incorporates copyright protection technology that is protected by method claims of certain U.S. patents and other intellectual property rights owned by Macrovision Corporation and other rights owners. Use of this copyright protection technology must be authorized by Macrovision Corporation, and is intended for home and other limited viewing uses only unless otherwise authorized by Macrovision Corporation. Reverse engineering or disassembly is prohibited.

Region Management Information

This Mobile DVD Player is designed and manufactured to respond to the Region Management Information that is recorded on a DVD disc. If the Region number described on the DVD disc does not correspond to the Region number of this Mobile DVD Player, this Mobile DVD Player cannot play this disc.

SAFETY INFORMATION

CAUTION:

MOBILE DVD PLAYER IS A CLASS 1 LASER PRODUCT. HOWEVER THIS MOBILE DVD PLAYER USES A VISIBLE/INVISIBLE LASER BEAM WHICH COULD CAUSE HAZARDOUS RADIATION EXPOSURE IF VIEWED DIRECTLY. BE SURE TO OPERATE THE MOBILE DVD PLAYER CORRECTLY AS INSTRUCTED. USE OF CONTROLS OR ADJUSTMENTS OR PERFORMANCE OF PROCEDURES OTHER THAN THOSE SPECIFIED HEREIN MAY RESULT IN HAZARDOUS RADIATION EXPOSURE. DO NOT OPEN COVERS AND - DO NOT REPAIR YOURSELF. REFER SERVICING TO QUALIFIED PERSONNEL.

WARNING:

- TO REDUCE THE RISK OF FIRE OR ELECTRIC SHOCK, DO NOT EXPOSE THIS EQUIPMENT TO RAIN OR MOISTURE.
- TO REDUCE THE RISK OF FIRE OR ELECTRIC SHOCK, AND ANNOYING INTERFERENCE, USE ONLY THE RECOMMENDED ACCESSORIES.

NOTICE OF INTENDED USE

Rosen Entertainment Systems are designed to enable viewing of video ONLY for rear-seat occupants, and are not intended for viewing by driver when the vehicle is in motion. Such use might distract the driver or interfere with the driver's safe operation of the vehicle, and thus result in serious injury or death. Such use might also violate state or local laws. Rosen Entertainment Systems disclaims any liability for any bodily injury or property damage that might result from any improper or unintended use.

DISC NOTES

Disc formats supported by this player



DVD
12 cm disc



Video CD
12 cm disc



CD
12 cm disc



MP3
12 cm disc

Handling and Cleaning

- Dirt, dust, scratches and warping disc will cause misoperation.
- Do not place stickers or make scratches on discs.
- Do not warp discs.
- A disc should always be kept in its case when not in use to prevent from damaging.
- Do not place discs in the following places:
 1. Direct sunlight
 2. Dirty, dusty and damp areas
 3. Near car heaters
 4. On the seats or dashboard

Disc Cleaning

Use a dry soft cloth to wipe the surface. If the disc is dirty, use a soft cloth slightly moistured with isopropyl (rubbing) alcohol. Never use solvents such as benzine, thinner or conventional record cleaners as they may mar the surface of the disc.

Note

A disc may become somewhat scratched (although not enough to make it unusable) depending on how you handle it and conditions in the usage environment. Note these scratches are not an indication of any problem with the player.

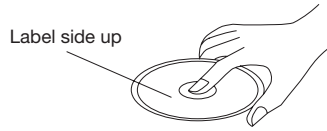

Label side up



Do not touch the underside of the disc



Do not bend

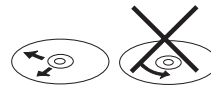

Wipe the disc from center toward the outside edge

Preparing New Discs with Rough Spots

A new disc may have rough edges on its inside and outside edges. If a disc with rough edges is used, the proper setting will not be performed and the player will not play the disc. Therefore, remove the rough edges in advance by using a ball point pen or pencil as shown below. To remove the rough edges, press the side of the pen or pencil against the inside and outside edges of the disc.

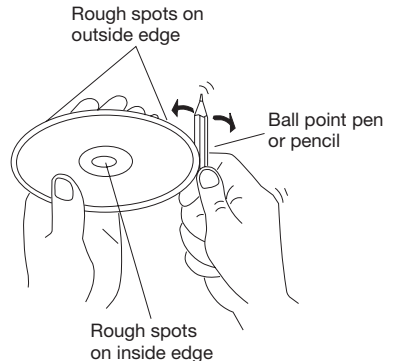

THE PLAYER

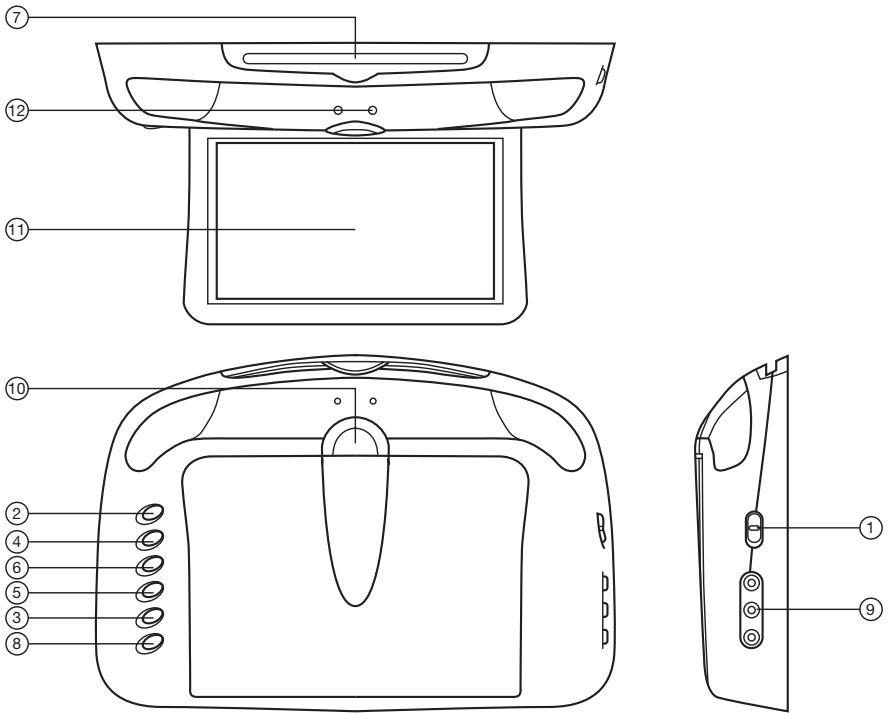

- 1. Dome Lamp Switch
- 2. EJECT (▲)
- 3. MODE
- 4. PLAY/PAUSE (▶||)
- 5. ◀◀ Chapter Back
- 6. ▶▶ Chapter Forward
- 7. Disc slot







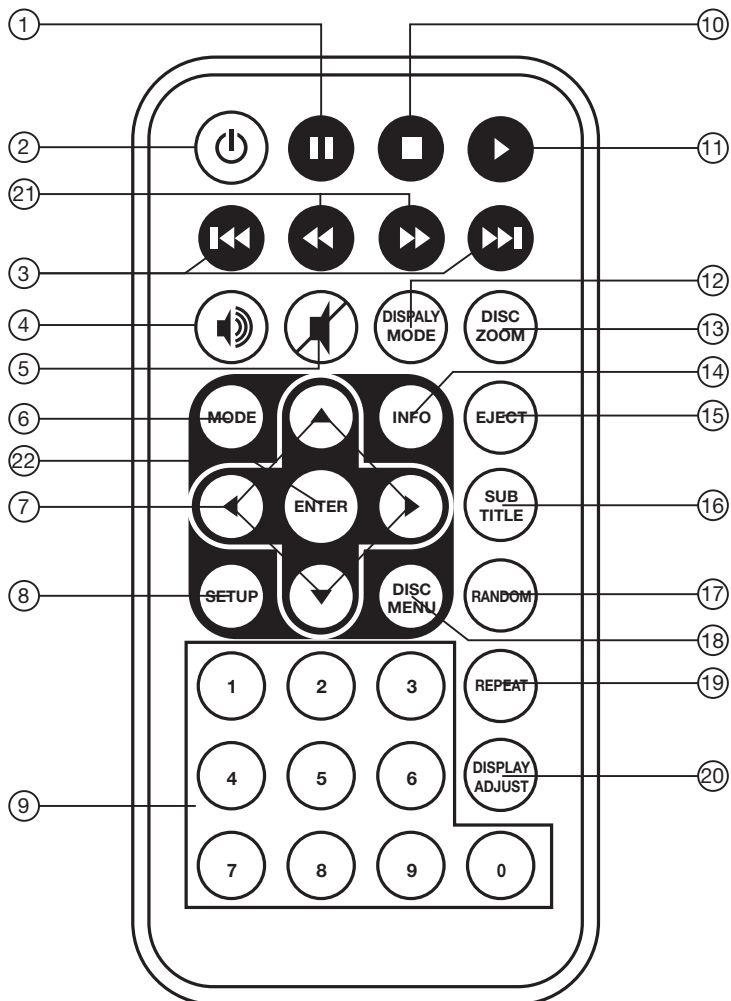











- 8. Speaker Enable Switch
- 9. AV IN Interface
- 10. Monitor release Button
- 11. TFT Color Monitor
- 12. Indicator LED of mode

REMOTE CONTROL

LOCATION AND FUNCTION KEYS



REMOTE CONTROL

1.  Press it to pause playback.
2.  Press it to turn the unit ON or OFF.
3.  /  Press  to skip to the next track & press  to skip back one track.
4.  Press it to enable or disable sound through the car radio.
5.  Press to mute the sound.
6. MODE Changing between DVD mode and AUX mode.
7.  / ,  /  Cursor buttons.
8. SETUP Display the SETUP menu.
9. 0-9 Numeric buttons
10.  Press it to stop playback.
11.  Press to play the disc.
12. DISPLAY MODE Press it to change the display mode among WIDE, STANDARD and ZOOM.
13. DISC ZOOM Allows the picture to be increased in size.
14. INFO Display disc information during playback.
15. EJECT Press to eject the disc.
16. SUBTITLE Changing of the SUBTITLE language on multi-subtitle language DVD disc.
17. RANDOM Allows the track played in random order.
18. DISC MENU Shows the DVD disc menu.
19. REPEAT Switch the Repeat mode of discs.
20. DISPLAY ADJUST Shows menus to adjust the display.
21.  /  Press  to search forward rapidly &  to search reverse rapidly.
22. ENTER Use ENTER to confirm a selection.

REMOTE CONTROL

Preparing the Remote Control

Inserting the Batteries

1. Open the battery compartment cover.
2. Insert the new batteries. Make sure that the positive and negative terminals of the batteries are oriented as indicated.
3. Close the cover
Battery: one button cell lithium battery, CR2025.

Using the Remote Control

Point the remote control towards the base of the unit.

Operation angle: About ± 30 degrees in each the direction of the base of the unit.

LOADING/EJECTING A DISC

Loading a Disc

When you have installed the unit and all connections have completed, you can load a disc as follows:

1. Press the **OPEN** button (1), to release and turn on the monitor.
2. Insert the disc with printed side facing up into the disc slot (2).
3. The player will start playback automatically.

Ejecting a Disc

Press **▲ (EJECT)** button (3) to eject the disc.

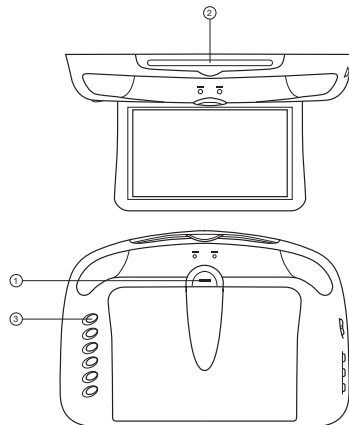

OPERATION

BASIC PLAY

STOPPING PLAY

- Briefly press the ■ (Stop) button to stop the unit playback, when the ► (Play) button is pressed, normal playback will continue.
- Press ■ (Stop) button twice to stop the playback and go back to initial Track/Chapter.

RAPID FORWARD/RAPID REVERSE

Press ►► / ◀◀ during play. Each time the button is pressed, the speed of rapid forward/reverse changes according to the disc as follow.

DVD:

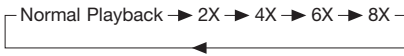

VCD/CD:

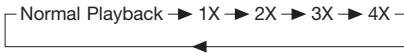

MP3:

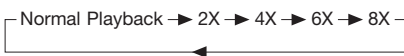

SKIPPING TRACK

Press ►► / ◀◀ buttons on the remote control during playback.
Press ►► to skip to next track, and ◀◀ to back one track.

PAUSE

Pressing || on the remote control or ►|| on the front panel of the DVD unit during playback will stop play temporarily. To return to normal playback, press ► on the remote control or ►|| on the front panel.

MUTE

Press the ✖ button on the remote control will mute the sound, but the disc continues playing. When you unmute the sound (press the button again) the sound will resume.

REPEAT

FOR DVD:

Press **REPEAT** button to select repeat mode as follow.



FOR VCD/CD:

Press the **REPEAT** button to select repeat mode as follow.



1. Continuously repeat at the current chapter/track, when selected REP-ONE mode.
2. Select REP-ALL mode to continuously repeat all chapter/track on the current disc.
3. When the player finishes playback the last chapter/track, it will stop and display the elapsed time. When REPEAT OFF mode is selected, REP-ONE & REP-ALL disappears from screen display.

DISC MENU

Pressing the **DISC MENU** will show the DVD DISC MENU if a DVD is installed.

DISC ZOOM

Allows the picture to be increased in size. Press **DISC ZOOM** to toggle among 1.5 scale, 2.0 scale and 3.0 scale.
During Zoom mode, press ▲ / ▼, ◀ / ► buttons to move pictures up, down, left or right direction.

RANDOM (CD only)

Press **RANDOM** button, track selection will be made in random order. The display screen will show "SHUFFLE ON" on the screen. Press **RANDOM** button again, "SHUFFLE OFF" appears and release the mode.

MODE SELECTION

Press **MODE** button on the front panel of the unit or **MODE** button on the remote control to select among DVD/AUX mode.

LIGHT SWITCH

The two car dome lamps on the unit will be on in some needed situations. There are two settings for the car dome lamp operation. Refer to the light switch.

- State 1: To make the lamp turn on only when car doors are opened.
State 2: To turn on the lamp.

OPERATION

TURNING THE UNIT ON/OFF

Press **OPEN** button on the front panel to release and turn on the monitor.

FM TRANSMITTER FUNCTION





Press  button on the front panel or on the remote control to turn the FM TRANSMITTER ON or OFF.

DISPLAY ADJUST FUNCTION

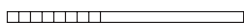
Press the **DISPLAY ADJUST** button on the remote control during DVD/AUX mode to display the adjustment items on the screen.

BRIGHTNESS	32
CONTRAST	32
COLOR	32
TINT	32



Press  /  button repeatedly to select among BRIGHTNESS, CONTRAST, COLOR, TINT (For the unit with NTSC system) . Press  /  buttons on the remote control to adjust the corresponding item.

ON-SCREEN DISPLAY FUNCTION

Press the **INFO** button during playback to display the contents of the current disc on the screen.

Example:

DVD:

(1) Press **INFO** for the first time:

TITLE 01/03 CHAPTER 002/025
00:02:25

Title Number, Total Title Number, Chapter Number, Total Chapter Number of this Title of the disc currently being played will be shown on the screen, along with the elapsed time.

(2) Press **INFO** for the second time:

TITLE REMAIN
01:46:58

(3) Press **INFO** for the third time:

CHAPTER ELAPSED
00:00:24

(4) Press **INFO** for the fourth time:

CHAPTER REMAIN
00:01:39

(5) Press **INFO** for the fifth time:

The message on the screen will be cleared.

VCD:

(1) Press **INFO** for the first time:

SINGLE ELAPSED
00:00:25

OPERATION

(2) Press **INFO** for the second time:

SINGLE REMAIN
00:03:15

(3) Press **INFO** for the third time:

TOTAL ELAPSED
00:00:25

(4) Press **INFO** for the fourth time:

TOTAL REMAIN
00:40:35

(5) Press **INFO** for the fifth time:
The message on the screen will be cleared.
CD:

(1) Press **INFO** for the first time:

SINGLE ELAPSED
00:00:25

TRACK : 01/14

(2) Press **INFO** for the second time:

SINGLE REMAIN
00:03:15

TRACK : 01/14

(3) Press **INFO** for the third time:

TOTAL ELAPSED
00:00:25

TRACK : 01/14

(4) Press **INFO** for the fourth time:

TOTAL REMAIN
00:40:35

TRACK : 01/14

(5) Press **INFO** for the fifth time:
The message on the screen will be cleared.

MP3 (When set to NO MENU in SMART NAV item):

(1) Press **INFO** for the first time:

CHAPTER ELAPSED 00:00:25

TRACK : 01/123

(2) Press **INFO** for the second time:

CHAPTER REMAIN 00:04:25

TRACK : 01/123

(3) Press **INFO** for the third time:
The message on the screen will be cleared.

MULTI-SUBTITLE LANGUAGE FUNCTION (FOR DVD ONLY)

Press **SUBTITLE** during playback. Each time the button is pressed, the subtitle language changes in sequential order.

Notes:







- The language number is different according to the disc.
- Some discs only contain one subtitle language.
- When no different subtitle language are recorded,  will be displayed at screen left top corner.

OPERATION

MP3 DISC PLAY

MP3 disc is playing as the format of FOLDER.

For example:

SMART NAVI	
 ROOT	
 CD01	MP3 001 PLUMT
 CD02	MP3 002 RZID
 CD03	MP3 003 ASCIS
 CD04	MP3 004 DCYI
 CD05	MP3 005 BFZ
PLAY MODE	DISC

In stop mode, use ▲ / ▼, ◀ / ▶ on the remote control to select the item or folder (such as CD01, CD02...), and press **ENTER** button on the remote control to confirm, then select the desired track (such as 001 PLUMT, 002 RZID...) on the current folder to play.

Pressing **REPEAT** button repeatedly can select three kinds of repeat play mode.

REP-ONE:

Play the same song over and again.

FOLDER REP:

Play all songs in the current directory in sequence, over and again.

FOLDER:

Play all songs in the current directory once.

When select PLAY MODE , press ▲ / ▼ to change between the following mode:

SINGLE → REP-ONE → FOLDER → FOLDER REP →

DISC SCAN → DISC → DISC REP →

SHUFFLE ON → PROGRAM PXXX

In the playback, use ▶▶ or ◀◀ to skip an item ahead or back.

◀◀ : Rapid reverse, ▶▶ : Rapid advance

Note: The FOLDER cannot be selected during playing. It can be selected after

■ (Stop) button pressed.

SETUP

INITIAL SETUP

SETUP MENU --- MAIN PAGE

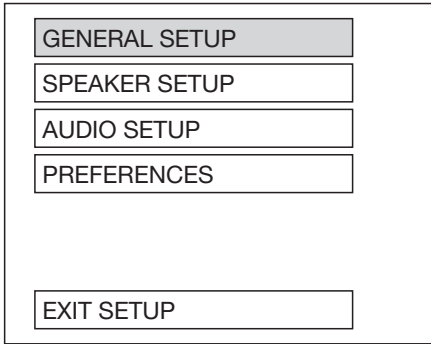

1. Press **SETUP** in the stop mode.
(Press the stop button twice to ensure the player is in STOP mode.)
2. The initial SETUP menu is displayed.
3. Select the preferred item by using the ▲/▼ buttons.
4. Press OK buttons.
 - a. **GENERAL SETUP**
This setup page includes all the item of TV display & audio output feature. For the detail please refer to **GENERAL SETUP MENU**.
 - b. **SPEAKER SETUP**
This is to activate the audio output from DOLBY AC3 5.1 DOWNMIX to 2 channel mode. Please refer to **SPEAKER SETUP MENU**.
 - c. **AUDIO SETUP**
This setup page includes all the items for AUDIO. Please refer to **AUDIO SETUP MENU**.
 - d. **PREFERENCE SETUP**
This setup page includes all the configuration of support feature. For the detail please refer to **PREFERENCES SETUP MENU**.

GENERAL SETUP

--- GENERAL PAGE ---

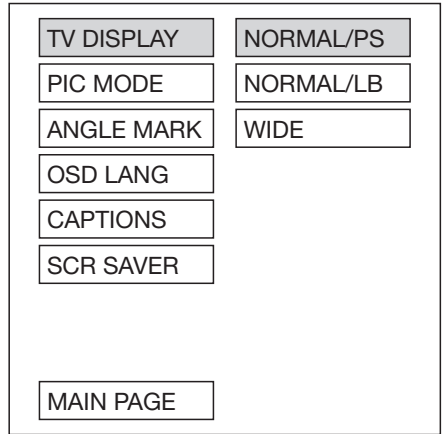

Video Material	TV Screen			
	4:3			Wide (16:9)
	Normal	Pan Scan	Letter-box	
4:3				
16:9				

Normal/PS (For 4:3 TV)

Played back in the PAN & SCAN style.
(If connected to wide-screen TV, the left and right edges are cut off.)

Normal/LB (For 4:3 TV)

Played back in letterbox style.
(If connected to wide-screen TV, black bands appear at top and bottom of the screen.)

Wide (For 16:9 TV)

Select when a wide-screen TV set is connected.

SETUP

--- GENERAL PAGE ---

TV DISPLAY	
PIC MODE	AUTO
ANGLE MARK	HI-RES
OSD LANG	N-FLICKER
CAPTIONS	
SCR SAVER	
MAIN PAGE	

PIC mode setup

Select AUTO, the player PIC mode will depend on DVD disc.
Select HI-RES format for best image resolution.
Select N-FLICKER format for image or picture with noise or distortion.

--- GENERAL PAGE ---

TV DISPLAY	
PIC MODE	
ANGLE MARK	
OSD LANG	ENGLISH
CAPTIONS	FRENCH
SCR SAVER	GERMAN
	ITALIAN
	SPANISH
MAIN PAGE	

OSD LANG type setup

Select the preferred OSD (On Screen Display) language by using the ▲/▼ buttons.

--- GENERAL PAGE ---

TV DISPLAY	
PIC MODE	
ANGLE MARK	ON
OSD LANG	OFF
CAPTIONS	
SCR SAVER	
MAIN PAGE	

ANGLE MARK display setup

If it is set to ON, when the multi-angle DVD disc is playing, ∞ (the angle mark) will appear on the screen; if it is set to OFF, the mark will not appear.

--- GENERAL PAGE ---

TV DISPLAY	
PIC MODE	
ANGLE MARK	
OSD LANG	
CAPTIONS	ON
SCR SAVER	OFF
MAIN PAGE	

CAPTIONS setup

When playing DVD disc, activate the CAPTIONS feature by selecting ON and the captions (such as the actor dialogue) appear on the screen; deactivate this feature by selecting OFF and the captions will not appear.

SETUP

--- GENERAL PAGE ---

TV DISPLAY	
PIC MODE	
ANGLE MARK	
OSD LANG	
CAPTIONS	
SCR SAVER	ON
	OFF
MAIN PAGE	

SCREER SAVER setup

Select the SCR SAVER ON/OFF.

SPEAKER SETUP

--- SPEAKER SETUP PAGE ---

DOWNMIX	LT/RT
	STEREO
MAIN PAGE	

This is to activate the audio output from DOLBY AC3 5.1 DOWNMIX to 2 channel mode. Select the preferred SPEAKER connection by using the cursor buttons.

- Select the LT/RT to activate the Dolby surround compatible output.
- Select the STEREO to activate simple stereo mode.

AUDIO SETUP

--- AUDIO SETUP ---

OP MODE	LINE OUT
LPCM OUTPUT	RF REMOD
DYNAMIC	
MAIN PAGE	

OP MODE

- LINE OUT: Line out mode, with digital dialog normalization.
 - RF REMOD: RF remodulation mode, with heavy compression and digital dialog normalization.
- It is recommended to select LINE OUT mode.

--- AUDIO SETUP ---

OP MODE	LPCM 48K
LPCM OUTPUT	LPCM 96K
DYNAMIC	
MAIN PAGE	

LPCM OUTPUT

Select the LPCM (Line Pulse Code Modulation) OUTPUT between LPCM 48K and LPCM 96K. The higher the sampling frequency is, the better the output audio quality is. It is recommended to select LPCM 96K.

SETUP

--- AUDIO SETUP ---

OP MODE	
LPCM OUTPUT	
DYNAMIC	
	FULL
	6/8
	4/8
	2/8
	OFF
MAIN PAGE	

DYNAMIC Range Control

Select DYNAMIC and adjust the dynamic range of a Dobyly Digital encoded program. There are 8 steps between full compression and off compression.

PREFERENCES SETUP

--- PREFERENCES PAGE ---

TV TYPE	AUTO
AUDIO	NTSC
SUBTITLE	PAL
DISC MENU	
PARENTAL	
PASSWORD	
DEFAULTS	
SMART NAV	
MAIN PAGE	

TV type setup

This player can play discs recorded in either PAL or NTSC format.

Select NTSC format, when the unit is connected to NTSC TV.

Select PAL format, when the unit is connected to PAL TV.

Select AUTO format, the player TV output format will be according to the DVD disc format.

--- PREFERENCES PAGE ---

TV TYPE	
AUDIO	ENGLISH
SUBTITLE	FRENCH
DISC MENU	SPANISH
PARENTAL	CHINESE
PASSWORD	JAPANESE
DEFAULTS	GERMAN
SMART NAV	ITALIAN
MAIN PAGE	

AUDIO language setup

Select the preferred AUDIO soundtrack by using the cursor buttons.

--- PREFERENCES PAGE ---

TV TYPE	
AUDIO	
SUBTITLE	ENGLISH
DISC MENU	FRENCH
PARENTAL	SPANISH
PASSWORD	CHINESE
DEFAULTS	JAPANESE
SMART NAV	GERMAN
	ITALIAN
MAIN PAGE	OFF

SUBTITLE language setup

Select the preferred SUBTITLE language by using the cursor buttons.

SETUP

--- PREFERENCES PAGE ---

TV TYPE	
AUDIO	
SUBTITLE	
DISC MENU	ENGLISH
PARENTAL	FRENCH
PASSWORD	SPANISH
DEFAULTS	CHINESE
SMART NAV	JAPANESE
	GERMAN
MAIN PAGE	ITALIAN

--- PREFERENCES PAGE ---

TV TYPE	
AUDIO	
SUBTITLE	
DISC MENU	
PARENTAL	
PASSWORD	CHANGE
DEFAULTS	
SMART NAV	
MAIN PAGE	

DISC MENU language setup

Select the preferred DISC MENU language by using the cursor buttons.

--- PREFERENCES PAGE ---

TV TYPE	1 G
AUDIO	2
SUBTITLE	3 PG
DISC MENU	4 PG 13
PARENTAL	5
PASSWORD	6 PG-R
DEFAULTS	7 NC-17
SMART NAV	8 ADULT
	NO PARENTAL
MAIN PAGE	

PARENTAL

Select suitable parental guidance by the cursor buttons and confirmed by pressing ENTER button.

PASSWORD

Select CHANGE and press ENTER button. Type the old password (The initial factory code is 3308) and key in 4 characters password now you want to use, and retype again to confirm key in correctly.

--- PREFERENCES PAGE ---

TV TYPE	
AUDIO	
SUBTITLE	
DISC MENU	
PARENTAL	
PASSWORD	
DEFAULTS	RESET
SMART NAV	
MAIN PAGE	

DEFAULTS

Select reset to become factory initial setting.

SETUP

--- PREFERENCES PAGE ---

TV TYPE
AUDIO
SUBTITLE
DISC MENU
PARENTAL
PASSWORD
DEFAULTS
SMART NAV
NO MENU
WITH MENU
MAIN PAGE

SMART NAV

If selected WITH MENU mode, when playing an MP3 disc, the smart navigation menu will appear on the screen, then the user can select a track to play according to the menu hint.
 If selected NO MENU mode, when playing an MP3 disc, there is no menu to display and it starts to play directly.
 The user can adjust this item according to one's need.

DEFAULTS TABLE

General Setup	TV Display	Normal/PS
	PIC Mode	AUTO
	Angle Mark	ON
	OSD Language	English
	Captions	ON
	SCR Saver	OFF
Speaker Setup	Downmix	Stereo
Audio Setup	OP Mode	Line Out
	LPCM Output	LPCM 96K
	Dynamic	FULL
Preferences	TV Type	AUTO
	Audio	English
	Subtitle	English
	DISC Menu	English
	Parental	NO_Parental
	Password	Change
	Smart NAV	With Menu

INSTALLATION

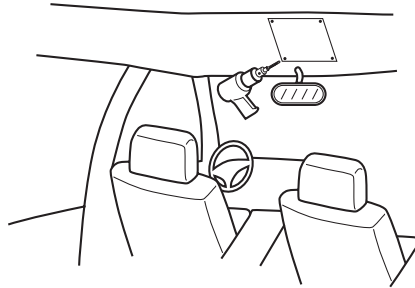

Fig. 1

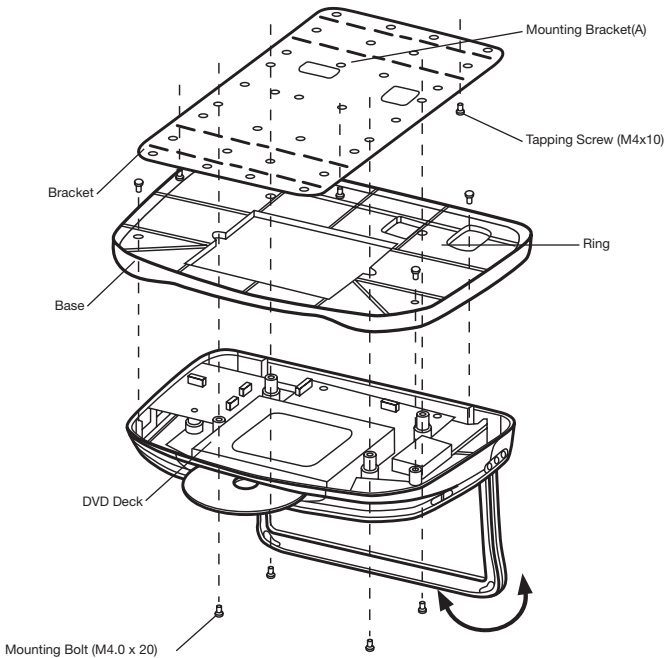
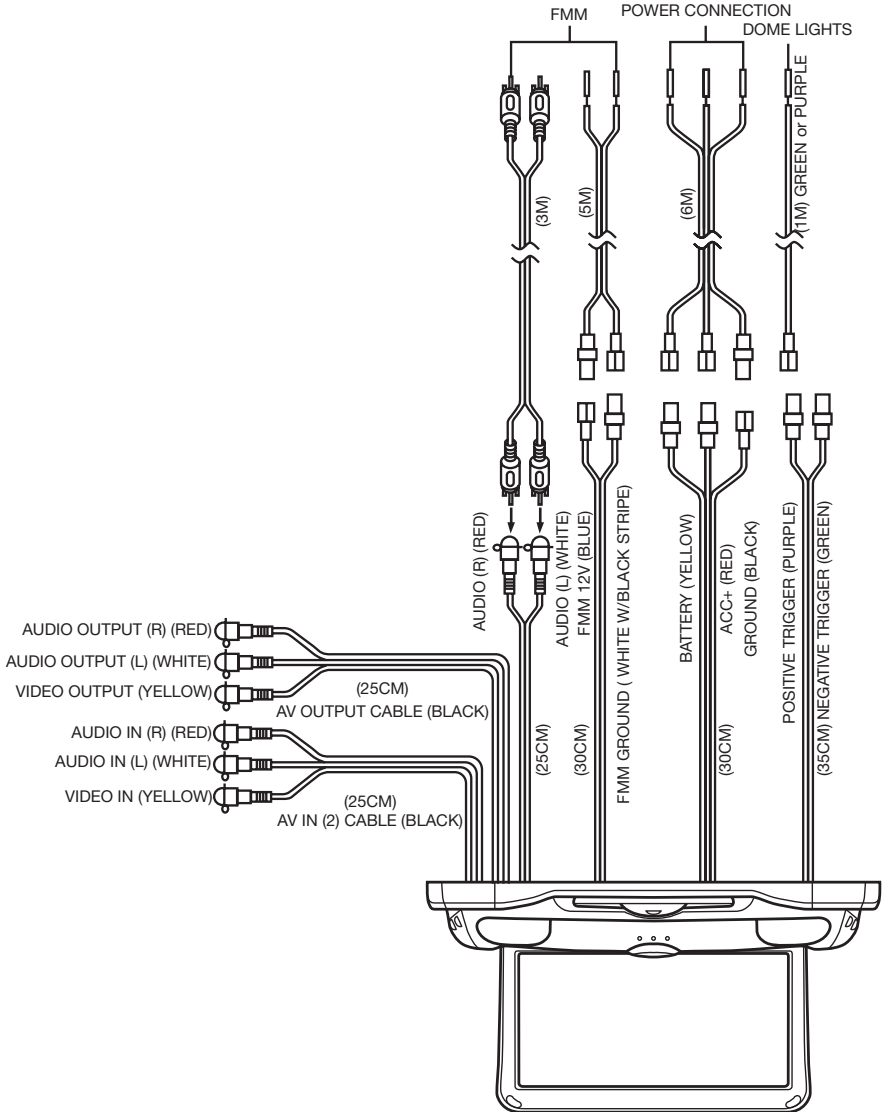

Fig. 2

1. Determine the mounting location and drill four mounting holes on the ceiling (See Fig.1).
2. Attach the mounting bracket (A) to the mounting holes on the ceiling with screws matching with the screw holes on the bracket (A).
3. Install the ring to the DVD unit with screws.

ELECTRICAL CONNECTION



REPLACING THE CAR DOME LAMP

There are two car dome lamps on the DVD unit. Follow the directions shown below for a new lamp changing.

1. Be sure the lamp is off. Push back the lamp cover and open it.
2. Remove and discard the old lamp.
3. Install a new bulb.
4. Close the cover.

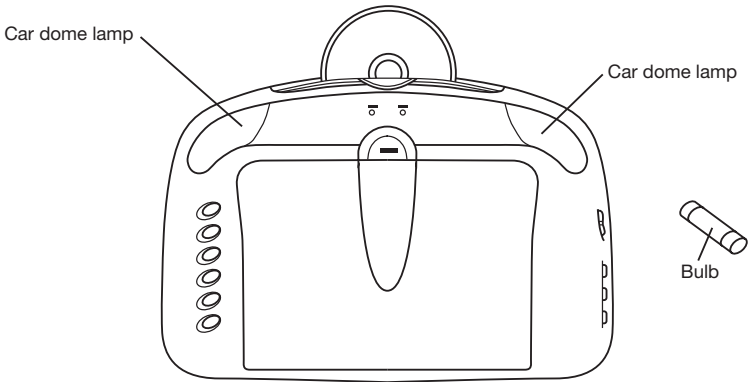

Bulb Specification

Diameter: ø8mm
Length: 28mm
Voltage Spec.: DC12V, 5W

TROUBLE SHOOTING

If it appears that your DVD unit is faulty, first consult this checklist. It may be that something simple has been overlooked.

Under no circumstances should you try to repair the player yourself, as this will void the warranty. Only qualified service personnel can remove the cover or service this player.

NO POWER

- Check the fuse to the system.
- Check to see if the vehicle voltage is above 11V DC.

NO PICTURE

- Check if the mode is set to proper state, such as DVD mode, TV mode or AV mode.

DISTORTED PICTURE

- Check the disc for fingerprints and clean with soft cloth, wiping from center to edge.
- Sometimes a small amount of picture distortion may appear. This is not a malfunction.

COMPLETELY DISTORTED PICTURE

- The disc format is not according to the TV-set used (PAL/NTSC).

NO COLOR IN PICTURE

- The disc format is not according to the TV-set used (PAL/NTSC).

DISC DOES NOT PLAY

- Ensure the disc label is upwards.
- Clean the disc.
- Check the mute status.

NO SOUND

- Check the batteries in the headphones.
- Check audio connections.

NO RETURN TO START-UP SCREEN WHEN DISC IS REMOVED

- Press POWER to turn off the unit, then press it again to turn on the unit.

THE PLAYER DOES NOT RESPOND TO THE REMOTE CONTROL

- Aim the remote control directly at the sensor on the front of the player.
- Avoid all obstacles which may interfere with the signal path.
- Inspect or replace the remote control batteries.

BUTTONS DO NOT WORK

- Turn the player off and on with the power on/off button on the front of the player.

SPECIFICATIONS

Supply Voltage	: 12V DC (11V-15V), test voltage 14.4V, negative ground
Current Consumption	: Less than 2A
Signal System	: Compositive video 1.0Vp-p 75Ω
Discs Played	: (1) 5" (12 cm) DVD-VIDEO Disc (2) Compact Disc (CD-DA/CD-R/CD-RW/MP3) (3) 5" (12cm) VIDEO CD
Operating temp	: 0°C to +50°C

Note:

Specifications and design are subject to modification, without notice, due to improvements in technology.